

# Infrared Sauna

## USER MANUAL



PLEASE NOTE: The circuit for this product must be installed by a certified electrician, select a circuit breaker according to the electrical codes in your area

# ENGLISH

## Warning

Please read this manual carefully and follow the instructions, otherwise it may lead to danger!  
Please keep this manual for future reference.

# German

## Warnung

Bitte lesen Sie dieses Handbuch sorgfältig durch und befolgen Sie die Anweisungen, da es sonst zu Gefahren kommen kann!  
Bitte bewahren Sie dieses Handbuch zum späteren Nachschlagen auf.

# français

## note

S' il vous plaît, lisez attentivement cette instruction et appliquez strictement le contenu du livre, sinon danger!  
Je vous prie de bien vouloir conserver cet ouvrage pour une référence ultérieure.



# Safety Warning

## Precautions

- 1.Children must be used under the supervision of an adult, and do not play with the device to prevent danger.
- 2.The power cord plugs, sockets and switches of the equipment should be located in places out of the reach of children, and should be protected from rain to prevent danger.
- 3.Do not insert objects such as fingers or sticks into the heating element (plate) to prevent danger.
- 4.Do not use or store flammable gases or liquids such as hairspray, paint, gasoline, etc. near or in the equipment to avoid fire.
- 5.Do not place objects in or on top of the sauna.
- 6.If the power cord is damaged, it must be replaced by a service provider or professional to avoid danger.
- 7.Use of the device during thunderstorms is prohibited.
- 8.If it works continuously for more than 4 hours, it should be turned off for half an hour.
- 9.Do not carry out repairs without authorization, the consequences of unauthorized repairs are not within the scope of our responsibility.
- 10.It is forbidden to bring electronic devices with lithium batteries into this product (such as mobile phones, tablets, electronic watches, etc.).
- 11.It is forbidden to use the sauna without sauna stones.
- 12.Do not use chlorinated water (i.e. water in swimming pools) for watering the sauna stone.



## Usage prohibition







- 1.Use with caution after drinking alcohol.
- 2.Do not sleep inside the device while it is working.
- 3.It is contraindicated for those with skin erosion or unhealed wounds after surgery.
- 4.If you have any medical condition, you must consult a doctor before using the sauna.
- 5.5. Please consult your doctor before use when you are sick or taking medicine.
- 6.Do not use it after intense exercise. It is recommended to wait for about 30 minutes (the body temperature returns to normal) before use.
- 7.Do not use if you are or may become pregnant (excessive temperature may endanger the fetus).
- 8.Prolonged exposure to high temperatures can cause burns. Note: Overheating (dizziness, weakness, drowsiness and fainting) please discontinue use immediately.
- 9.Consult your doctor before use if you have obesity, heart disease, blood pressure problems, circulatory disease or diabetes.
- 10.Be careful about bumping your head in and out of the sauna.
- 11.This appliance is not intended for use by persons (including children) who are incapacitated, sluggish or mentally handicapped unless under the direction or assistance of a person responsible for their safety.











**Warnings on this page carefully and strictly follow, otherwise you may be injured.**





## Important safety warning









※ Please read the manual carefully before use, and strictly observe the following safety guide when using:

This safety precaution uses the following symbols to distinguish the harm and damage to the human body caused by misuse	
 <span style="background-color: #cccccc; padding: 2px 5px; font-weight: bold;">Warning</span> Indicates the possibility of serious injury.	 <span style="background-color: #cccccc; padding: 2px 5px; font-weight: bold;">Note</span> Indicates the possibility of personal injury or property damage

Symbolic indication		
 Indicates prohibited matters	 Indicates mandatory guidance	 Indicates guidelines
 Indicates that modification is prohibited	 Indicates that the power plug is unplugged	 Indicates attention to electric shock

 <span style="background-color: #cccccc; padding: 5px 10px; font-weight: bold;">Warning: Please follow the doctor's advice</span>	
 With a pacemaker embedded in the body	 Person with artificial heart
 High fever	 Patients with epilepsy
 Acutely ill patients	 Pregnant woman
 Infectious patients	 The perceptually impaired and the drunk
 This product is not intended for use by persons (including children) who are incapacitated, sluggish, or mentally handicapped unless under the direction or assistance of a person responsible for their safety	

 <span style="background-color: #cccccc; padding: 5px 10px; font-weight: bold;">Warning</span>	
 It is strictly forbidden to install any lock or hasp system on the door of this product without permission to prevent it from being trapped in the product in case of failure	 Do not put flammable materials into this product at any time to prevent fire
 Thunderstorm weather is strictly prohibited	 Do not bring mobile phones, MP3 players and other electronic products, digital products, and watches into this product

 <span style="background-color: #cccccc; padding: 5px 10px; font-weight: bold;">Attention</span>	
 When you feel suffocated when using this product, you should open the ventilation window	 When repairing this product, the power supply should be cut off to prevent electric shock
 If the product fails, please contact the maintenance personnel	 It is still strictly prohibited to install sockets and other electrical equipment in this product without permission
 This product is a high-power electrical, and the dedicated circuit provided for this product is not shared with other electrical appliances	 If you have symptoms such as discomfort, dizziness or drowsiness, you should stop using it immediately, otherwise staying in the product for a long time will cause excessive heat
 When the human body produces excessive heat. Do not use this product	

# contents



Safety warning .....	01
Important safety warning .....	02
Product construction diagram.....	03
Product installation .....	04
一. Preparation before installation.....	04
二. Installation method .....	04
三. Product installation.....	05
四.Product electrical connection circuit diagram	08
Product use .....	08
Troubleshooting .....	09

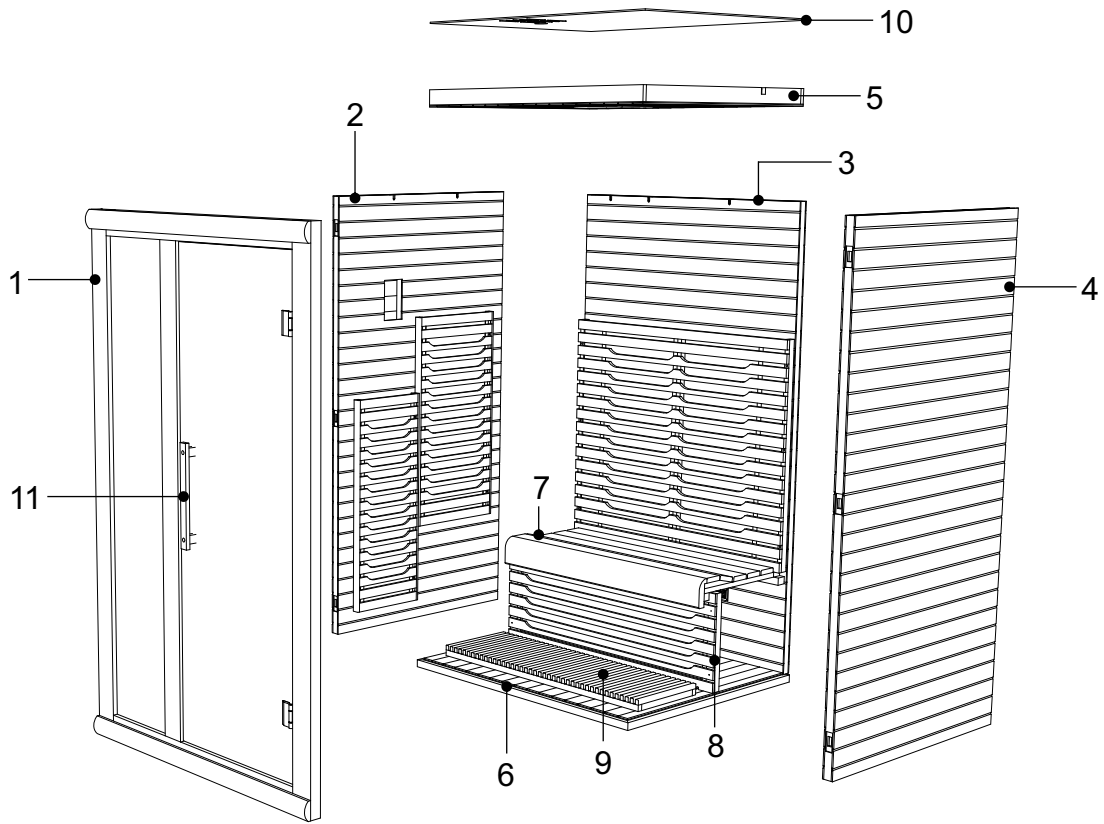

- |                    |                     |                       |                     |
|--------------------|---------------------|-----------------------|---------------------|
| 1: Front plate     | 4: Right side panel | 7: Seat plate         | 10: Dustproof board |
| 2: Left side panel | 5: Top cover        | 8: Seat support plate | 11: Door handle     |
| 3: Back panel      | 6: Base Frame       | 9: Step plate         |                     |

## Product installation

### Preparation before installation

1. Check whether the total number of packages is correct and whether the appearance of the package is in good condition.
2. After removing the outer packaging, pls check if the product components are complete and whether they are damaged.
3. Choose the location where you want to place the product: It is recommended not to install in a narrow, humid, long distance from the power supply, and easy to shake.
4. Prepare the necessary tools for installation (pictured below).

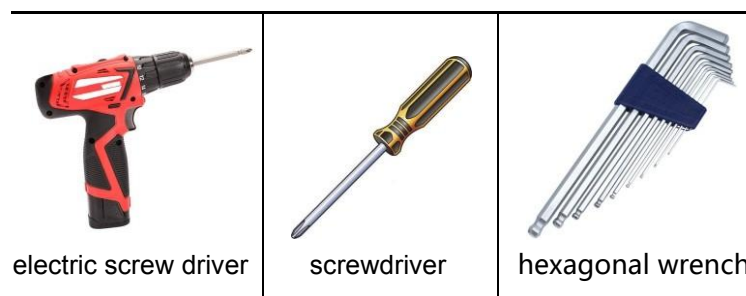

### Installation method

Different products have different modes and different connection methods. There will be one or more connection methods, make sure the connection is firm during the connection process.

The connection methods of the box are as follows:

#### • Buckle connection

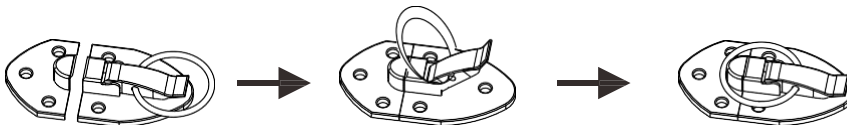

#### • Concealed buckle connection

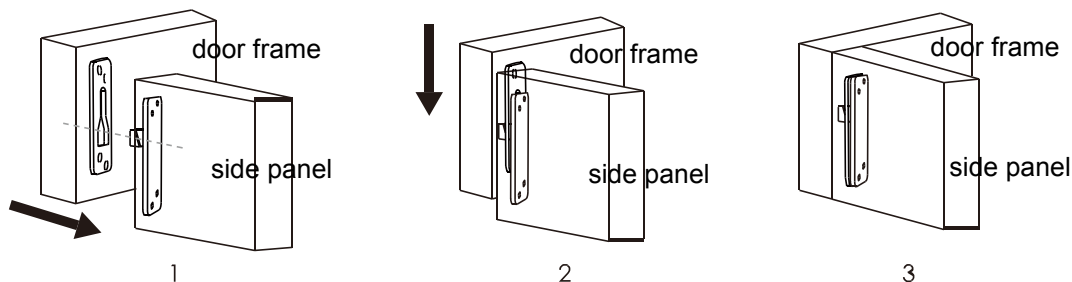

#### • Connection of screw

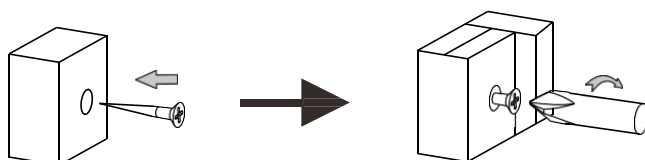

# Product installation

## Step 1

### 1. Place the base part

Place the base frame at the installation position, and distinguish the front and rear positions of the base frame according to the stickers on the base frame. In order to avoid damage to your floor, it is recommended not to move the sauna as a whole after installation. Therefore, it is recommended:

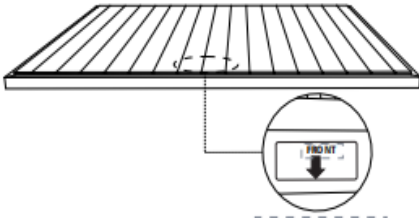

Pay attention to the front and rear direction, there are instruction stickers

- a). There is a power socket or wiring port at the selected location, and it is within the length of the power cord;
- b). Pay attention to the opening direction of the product to ensure that no other objects block the door when opening the door.

## Step 2

### 2. Place the back plate

Lift the rear panel, place the rear panel on the ground and align it with the bottom frame left and right, and arrange for personnel to support the rear panel to prevent injury from collapse.

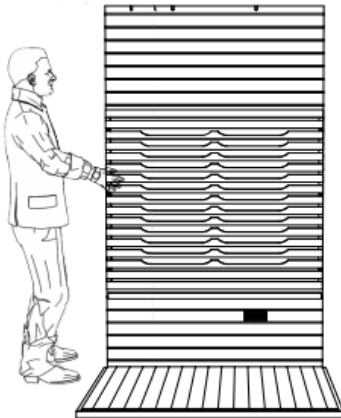

## Step 3

### 3. Place the left panel

Align the left side and the rear panel, align the card slots, and fasten the connection buckles.

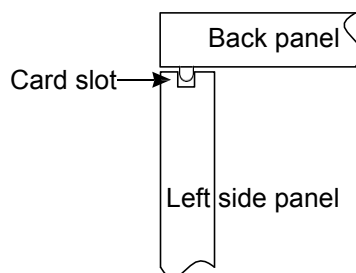
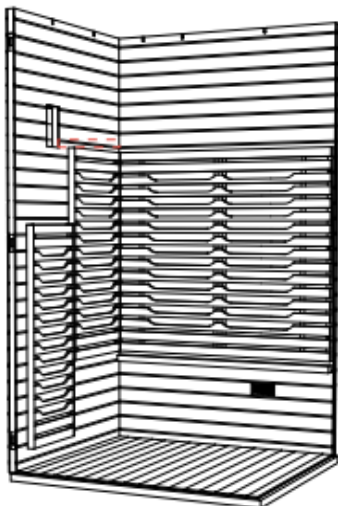

Align the card slots

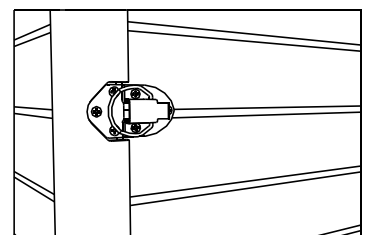

Firm the buckle



# Product installation

## Step 4

### 4. Place the right side panel

Align the right side panel and the rear panel, align the card slots, and firm the connection buckles

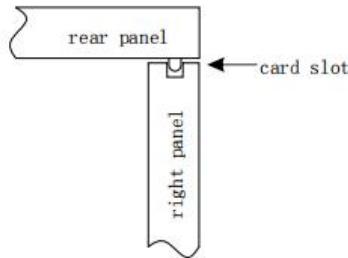
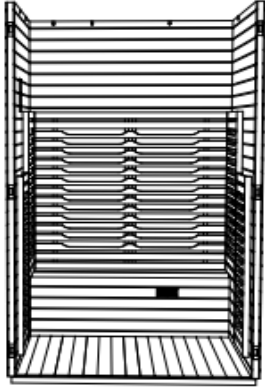

Align the card slot

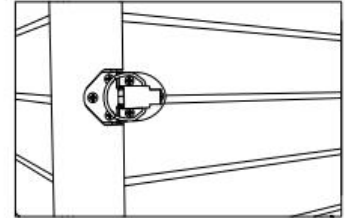

Fasten the buckle

## Step 5

### 5. Place the front panel

Align the front panel with the left and right side panels and place them in place with the same height as the left and right side panels. Use screws to connect the front panel and the left and right side panels.

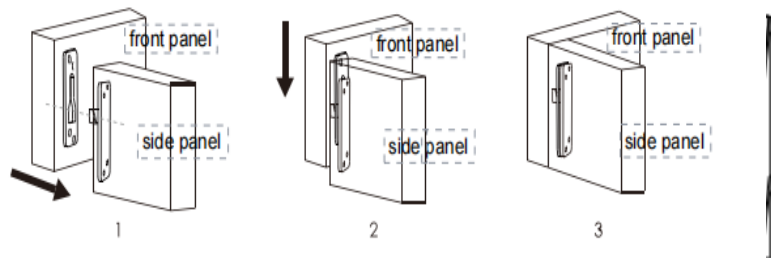
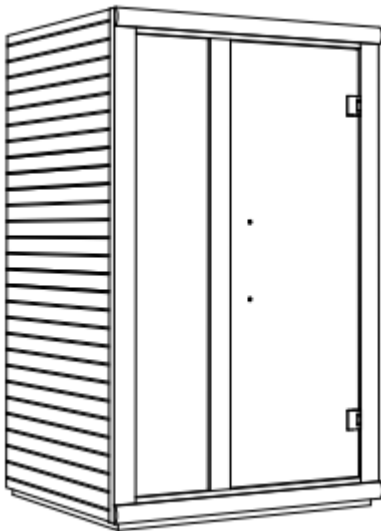

## Step 6

### 6. Place the top cover

Put the top cover in place. Because the sauna room is high, you need to use a pad when placing the top cover. couples people lift the top cover over the height of the room. When placing the top cover, special care should be taken not to crush the power cord on the side panel. Connect all power cords in place according to the power cord labels on the top cover.

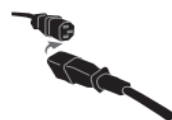
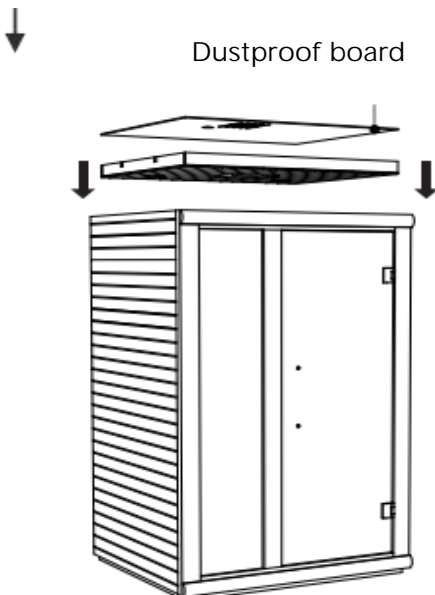

Heating board power wiring

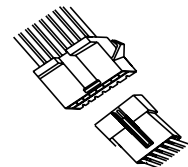

Control panel, lamp power cord connection

# Product installation

## Step 7

### 7.Plance seat side plate and step plate

Place the seat side plate and the step plate as shown below, Align the positioning bar on the right side panel when the seat stand is placed, and fix the seat stand with screws (according to different models, some models do not need screws on the side). Connect the power cord in place as shown.

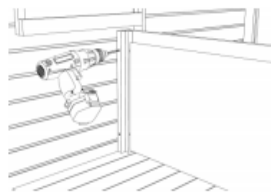
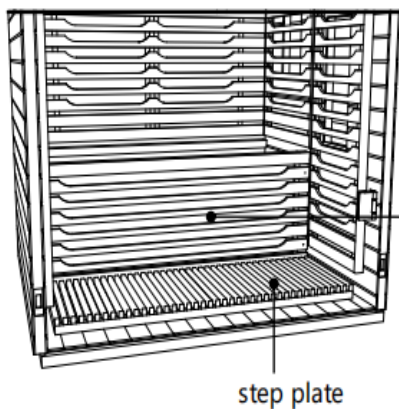

Secure the seat riser with screws M3×30=2PCS Connect the power cord

## Step 8

### 8.Place seat plate

Connect the power cord Install the seat panel in place according to the picture, and connect the ambient light cable of the seat panel according to the picture.

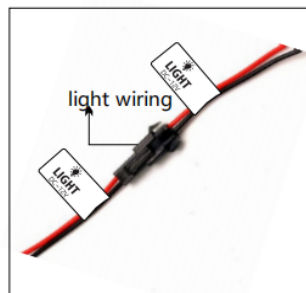
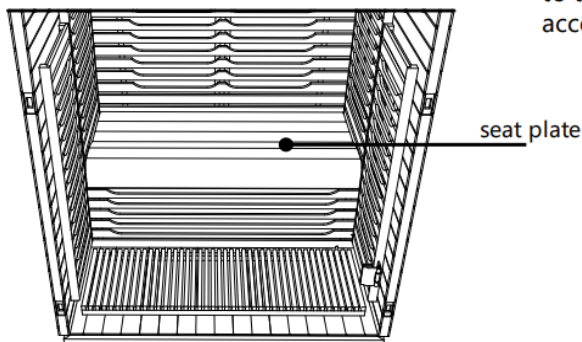

Schematic diagram of power cord connection for seat panel light bar

## Step 9

### 9.Diagram of handle installation

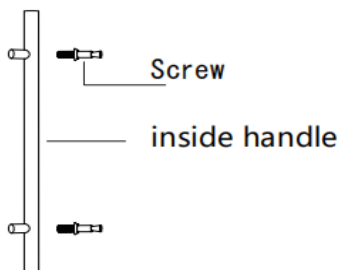
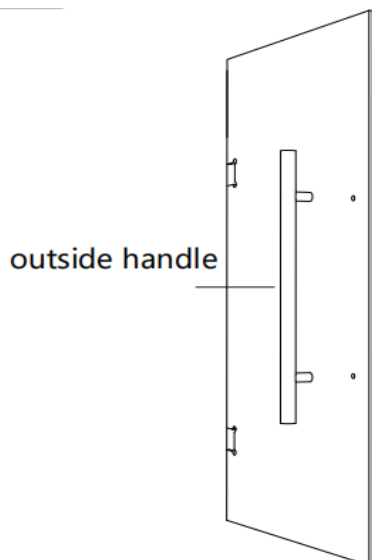

Screw M6\*60=2PCS

Electrical connection method

wiring diagram

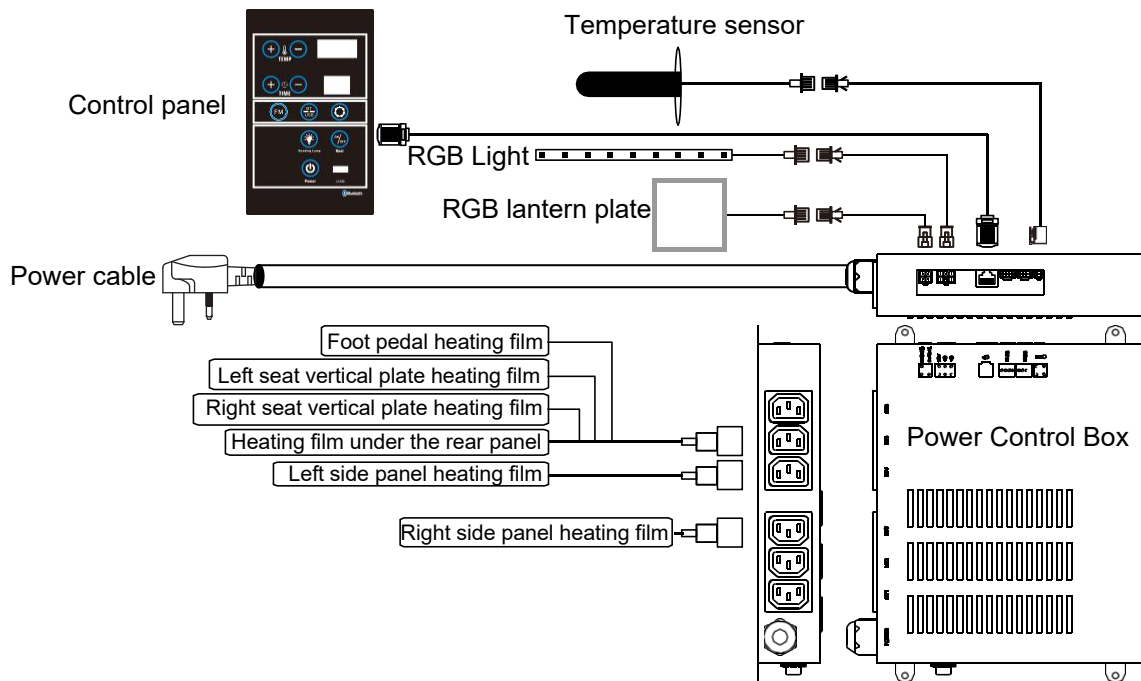

Control panel function introduction

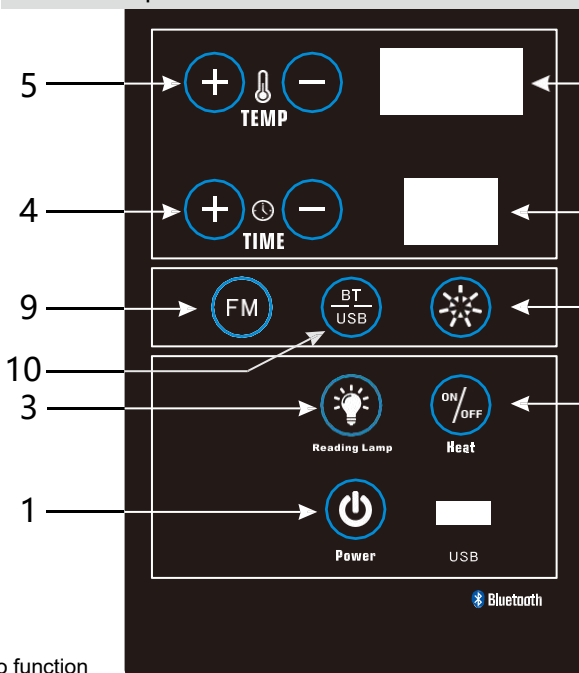

- 1 : switch on  
When ready, press the power button, the machine can run, the last setting will be memorized by default after power on, and the light of the power button will be on for a long time when the power is on.
- 2 : heating switch  
After power on, press the heating switch key, the machine can start heating, press and hold for 3 seconds to switch to degrees Celsius °C, Fahrenheit °F.
- 3: light on/off  
After the power is turned on, press the on-off key of the light to turn on the light. The light control sequence is: press once to turn on, press twice to turn off, press three times to turn on, and so on. For RGB lights, you need to press the color light adjustment button to turn off the lights.
- 4 : time adjustment, volume adjustment  
Adjust the timing time, Long press to quickly adjust, no operation within 3 seconds, save the setting parameters and the digital tube will flash from flashing to still. Multimedia volume is also adjusted here.
- 5: temperature adjustment, switch FM channels, switch songs  
Adjust the timing temperature, press and hold to quickly adjust, no operation within 3 seconds, save the setting parameters and the digital tube will flash from flashing to still. FM channel switching search, Bluetooth song switching
- 6 : Time display, volume display  
(1): Time display, the display range is 0-90 minutes.  
(2): Volume display, volume range 0-40, multimedia status display.
- 7 temperature display, multimedia display  
(1)Temperature display, the display range is 10-65 degrees Celsius.  
(2)Multimedia display, showing BT, indicating "Bluetooth" mode. U5B is displayed, indicating "USB" mode. FM is displayed, indicating that it is currently in "FM" mode.
- 8: RGB lantern function  
Turn on white by default, press it once to change a color, and press the button for the 8th time to turn off the RGB light.

● 9: FM radio function

Press this button to start the FM radio function, press the temperature adjustment button ⊕ within 5 seconds to automatically search the channel ⊖ upwards, and automatically search the channel downwards. After pressing the FM button for 5 seconds, the control system will switch back to the temperature display.

If need to adjust again, Please press the FM key again, and adjust the FM radio volume keys to the time "+", "-" keys.

● 10: Bluetooth and USB functions

Bluetooth and USB switch button, press and

hold for 3 seconds to switch to USB mode (the code tube displays USB), the Bluetooth

name is "SAUNA BT", the temperature adjustment buttons "+", "-" switch songs, and the time adjustment buttons "+", "-" adjust the volume.

Warm tips:

1. Do not wear gold and silver jewelry such as bracelets into the sauna room.
2. Do not place volatile substances such as drugs and alcohol in the sauna room.
3. When sauna is finished, the panel will make a "beep" sound, it is normal.

Important hint

When using the sauna room, it is forbidden to bring electronic equipment powered by lithium batteries into the sauna room to avoid potential safety hazards

NO.	Failure	Cause Analysis	Solution
1	The power indicator does not light up	No power input	Check whether the power cord is plugged in and connected properly
		The cable is not connected	Check whether the control panel cable is connected well, and whether the terminal of the cable is disconnected
		The power light is broken	Replace the relevant control panel
2	Far infrared heating film does not work	The power cable of the heating film is loose	whether the power cable is loose, plugged in tightly, and inserted in correct place
		The heating film is damaged	Replace the heating film of the same specification
		Temperature sensor failure	Check whether the wire of the temperature sensor is plugged in, the interface is loose, or replace it if damaged.
		Circuit board damage	Replacing the control box circuit board
3	Light is not on	The cable is not connected	Check whether the cable is connected, if not, please reconnected, and check whether the terminal of the wire is disconnected
		The lamp is broken	Replace the lamp with the same specification
4	No sound from speakers	The cable is not connected	Check whether the cable is connected, , if not, please reconnected, and check whether the terminal of the wire is disconnected
		Damaged speaker	Replace the speaker of the same specification
5	Sauna not working	The power plug is not plugged in properly	Check and plug it again
		Out of power outlet	Check the power outlet or wiring
		Damaged control box	Replacing the same specification control box
6	Temperature Display ER Code	The work button is not pressed	Press the heating button, if the problem still exists, please arrange the next step for trouble shooting
		Temperature sensor not connected	Check the temperature sensor are connected properly. If damaged, Replace the temperature sensor
		Temperature sensor damaged	Replace the temperature sensor of the same specification

※ If the problem is still not resolved, please contact us [info@alphasauna.com](mailto:info@alphasauna.com)